

Plan - single

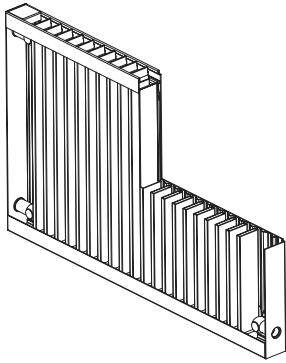

Plan single cutaway, rear view

Plan - double

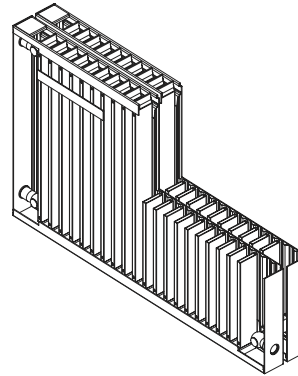

Plan double cutaway, rear view

Plan - single and double

Height and length

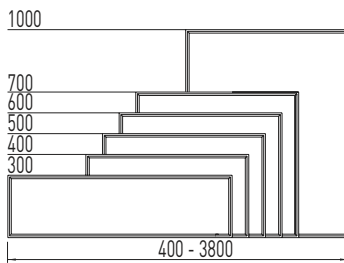

Plan single, profile

Plan double, profile

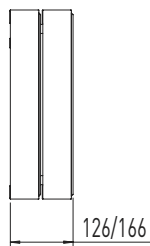

Weight max. 250 kg for Plan double

Plan - single and double with built-in valve

Built-in valve format 1

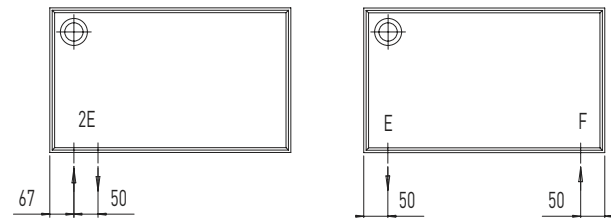

Built-in valve format 3

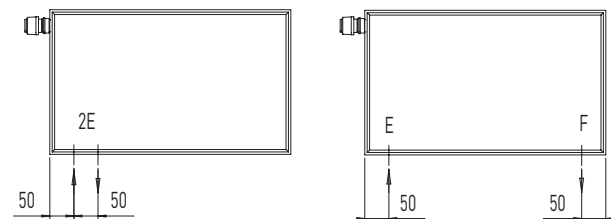

Built-in valve formats 1 and 3 can be delivered as follows:

- Downward facing tappings, 2E (left) or 2F (right)
- Downward facing tappings, EF
- Other options, please contact Hudevad

Length	Plan single and double: 400-3800 mm, with sections in increments of 33.33 mm
Height	Plan single and double: 300, 400, 500, 600, 700 and 1000 mm
Depth	Plan single: 40, 60 and 80 mm Plan double: 126 and 166 mm
Tappings	1/2" standard, adapter for 3/8" and 3/4"

Mounting	Wall or floor mounted Brackets are included Air vent is included
Colour	Powder coated in white RAL 9010. Gloss 70 Option: Painted in other standard RAL and BS colours
Options	- Model UR-flex - Angled and curved - Horizon infill and end panel system - Console feet FH

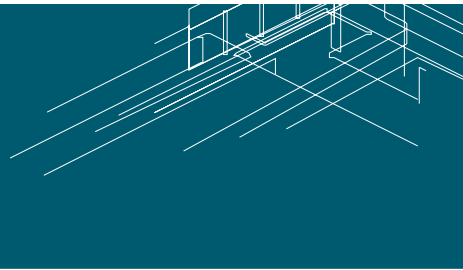

Output - single

Plan single, depth 40 mm	Output		Water content litres/metre	Weight kg/metre
	Height mm	W/metre		
		75°/65°/20°	90°/70°/20°	
300	387	481	1.9	16.6
400	526	661	2.6	21.8
500	665	843	3.4	26.7
600	805	1024	4.1	31.5
700	944	1205	4.7	36.2
1000	1253	1602	7.0	51.5

Plan single, depth 60 mm	Output		Water content litres/metre	Weight kg/metre
	Height mm	W/metre		
		75°/65°/20°	90°/70°/20°	
300	466	580	2.7	20.5
400	633	797	3.7	27.0
500	802	1020	4.9	33.2
600	969	1237	5.9	39.3
700	1137	1455	7.0	45.3
1000	1510	1941	10.4	64.5

Plan single, depth 80 mm	Output		Water content litres/metre	Weight kg/metre
	Height mm	W/metre		
		75°/65°/20°	90°/70°/20°	
300	511	645	3.5	24.4
400	695	882	4.9	32.2
500	879	1129	6.4	39.7
600	1064	1366	7.8	47.1
700	1247	1604	9.3	54.4
1000	1655	2129	13.7	77.5

Output - double

Plan double, depth 126 mm	Output		Water content litres/metre	Weight kg/metre
	Height mm	W/metre		
		75°/65°/20°	90°/70°/20°	
300	782	981	5.4	41.0
400	1064	1339	7.5	54.0
500	1345	1681	9.8	66.5
600	1628	2060	11.9	78.6
700	1909	2447	14.0	90.6
1000	2535	3248	20.7	129.0

Plan double, depth 166 mm	Output		Water content litres/metre	Weight kg/metre
	Height mm	W/metre		
		75°/65°/20°	90°/70°/20°	
300	858	1060	7.0	48.8
400	1167	1442	9.8	64.4
500	1476	1827	12.8	79.5
600	1785	2230	15.7	94.1
700	2095	2636	18.5	108.8
1000	2781	3537	27.4	155.0

Table 1

Depth, mm	C, mm	D, mm	E, mm
40	50/70	24/44	10/30
60	70/90	41/61	10/30
80	90/110	51/71	10/30
126	136/156	41/61	10/30
166	176/196	51/71	10/30

Build-in dimensions - single and double

Plan single, profile

Plan double, profile

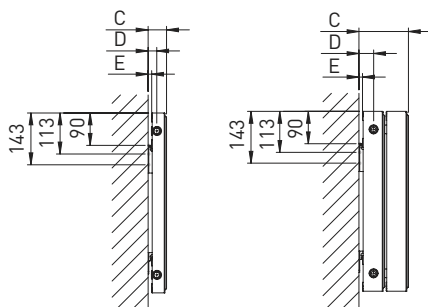

See table 1

Tapping designation - single and double

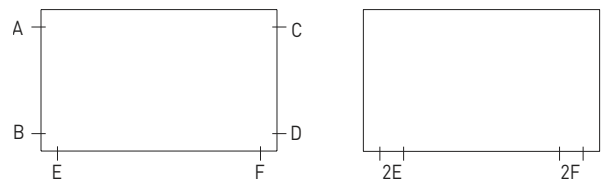

Tapping designation
Standard tappings: 1/2" ABCD

Tapping designation,
2E and 2F

Accessories - bracket

Bracket BP10/30

Spacer

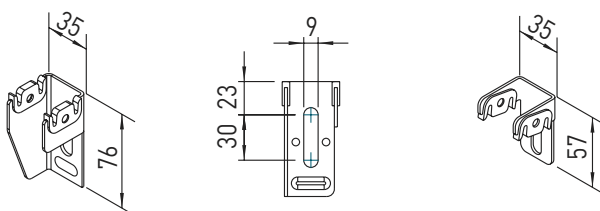

Accessories - feet

Adjustable console feet PR

FDC feet

