

Kampmann konkret

Roll-up Grilles • Linear Grilles

Decorative Air Outlets for Underfloor Convectors



Kampmann. Genau mein Klima.
KAMPMANN

Quick-Info

Scanning,
decoding,
using mobile content



- Turn your mobile device to the QR code
- Scan and decode using relevant software/App
- Use mobile content



Information

Quick Response code

Table of Contents

Overview of roll-up grilles	4
Variations	6
Optiline roll-up grilles – ultra-elegant narrow-spaced air outlets	8
Aluminium roll-up grilles – the sophisticated "all rounder"	10
Keyline roll-up grilles – creating a new benchmark in designer grilles	12
Brass roll-up grilles – the sophisticated grilles	13
Stainless steel grilles – contemporary and functional	14
Wooden roll-up grilles – warm and homely – decorative wooden covers	16
Linear grilles – decorative covers for air outlets - cannot be walked upon	18
Important order information • Installing frames	19
Type overview	20
Specifications	21
Your point of contact	26

Further information can be found on our website:



Kampmann.de

Our service for you

- Advice (on-site)
- Tailor-made solutions
- Control technology
- Seminars and training
- Project solutions
- Site measuring
- Design ideas
- Service

Roll-up Grilles

Overview

"Optiline" roll-up grilles	"Optiline" roll-up grilles
	
<p>Applications Residential buildings and salesrooms, industrial and commercial buildings</p>	<p>Applications Up-market residential and office buildings to meet exacting design requirements</p>
<p>Materials/Colours</p> <ul style="list-style-type: none"> • Aluminium, anodised <ul style="list-style-type: none"> – Natural anodised E6/EV1 – Brass anodised E6/EV3 – Bronze anodised E6/C34 – Bronze finish E6/C31 – Painted DB703 – Painted white 	<p>Materials/Colours</p> <ul style="list-style-type: none"> • Brass • Stainless steel • Stainless steel, polished
Page 8	Page 8

Aluminium roll-up grilles	"Keyline" roll-up grilles
	
<p>Applications Versatile load-bearing grille for residential properties, salesrooms and industrial and commercial buildings</p>	<p>Applications Perfect visual and functional integration into modern properties and offices</p>
<p>Materials/Colours</p> <ul style="list-style-type: none"> • Aluminium, <ul style="list-style-type: none"> – Natural anodised E6/EV1 – Brass anodised E6/EV3 – Bronze anodised E6/C34 – Bronze finish E6/C31 	<p>Materials/Colours</p> <ul style="list-style-type: none"> • Aluminium, <ul style="list-style-type: none"> – Natural anodised E6/EV1 – Brass anodised E6/EV3 – Bronze anodised E6/C34 – Bronze finish E6/C31
Page 10	Page 12

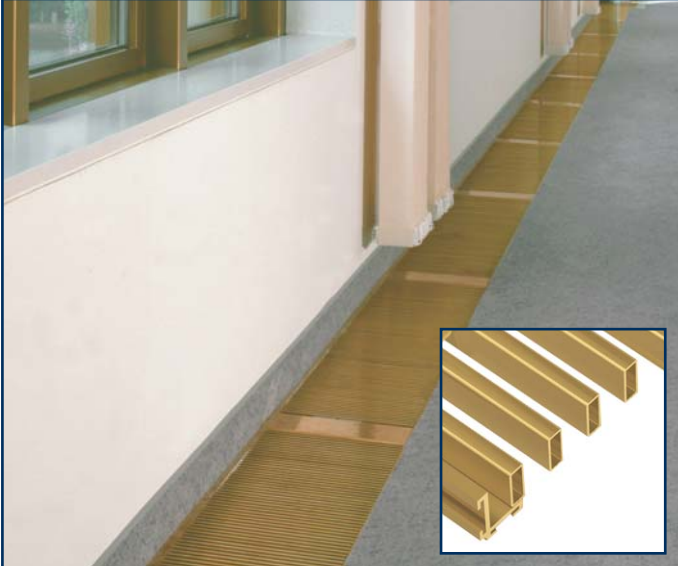
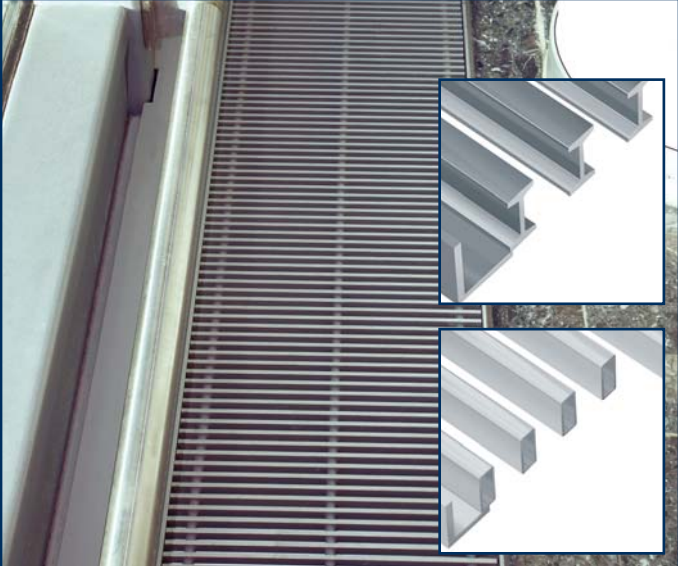
Brass roll-up grilles	Stainless steel roll-up grilles
	
<p>Applications For up-market residential and office buildings</p>	<p>Applications Stainless steel for up-market and modern residential buildings</p>
<p>Materials/Colours</p> <ul style="list-style-type: none"> Natural brass CuZn 37 	<p>Materials/Colours</p> <ul style="list-style-type: none"> Stainless steel Stainless steel, polished
<p>Page 13</p>	<p>Page 14</p>

Wooden roll-up grilles

<p>Applications The natural alternative for residential buildings, salesrooms and offices</p>
<p>Materials/Colours</p> <ul style="list-style-type: none"> Natural oak, varnished Natural beech, varnished Natural maple, varnished Natural merbau, varnished Oiled oak Oiled beech Oiled maple Oiled merbau
<p>Page 16</p>

Roll-up Grilles • Linear Grilles

Variations – (almost) everything is possible!

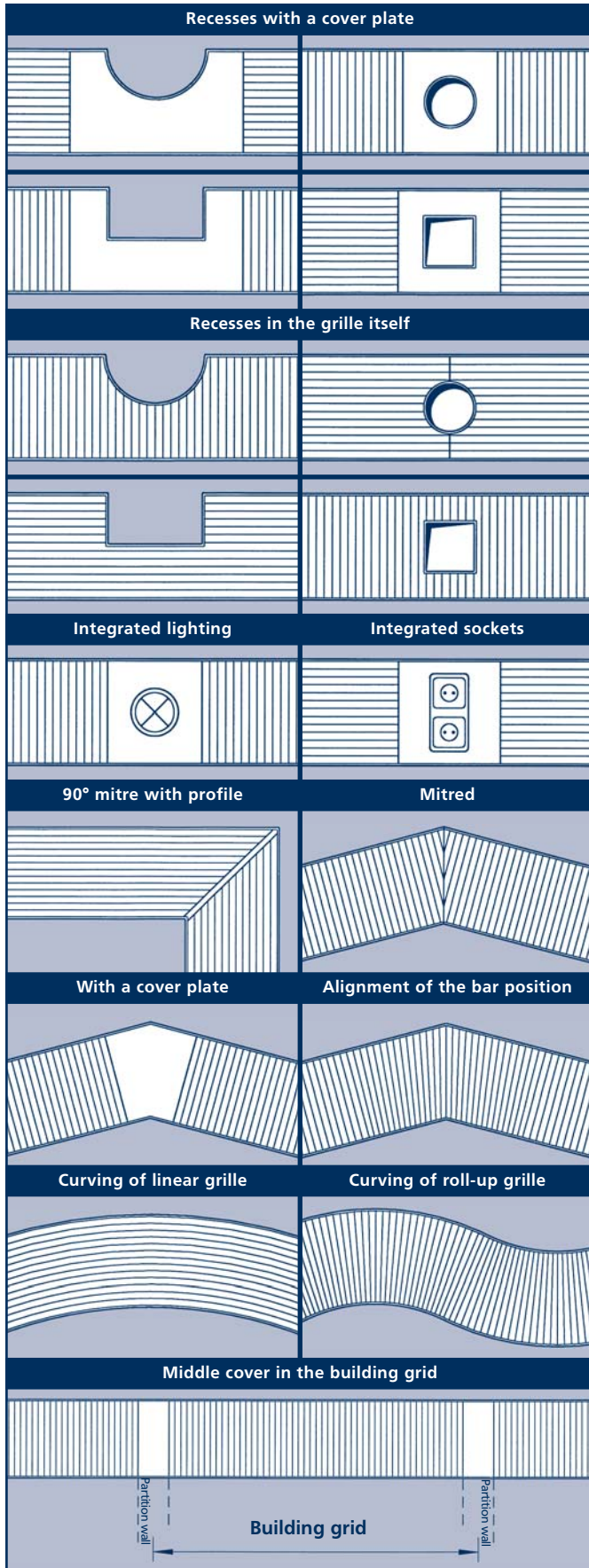

Variations – (almost) everything is possible!

Recesses

- in any form, to integrate parts of buildings, such as columns, mullions etc.
- different cover plate materials possible:
brass – anodised aluminium – stainless steel

Cover plate with partition walls

For example, when fitting a duct/trench to existing building grids

Cover plate with electrical installations

Integration of light fixtures or sockets

Curves

Any variation of components in a curved form

Chamfered edges

Corner variations

- mitred
- acute/obtuse angle
- 90 ° angle
- curved

Service

Site measuring by Kampmann specialists



Roll-up Grilles • Linear Grilles

Variations – (almost) everything is possible!

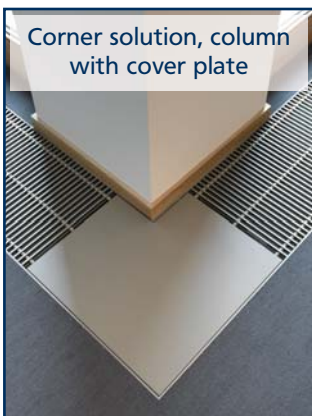
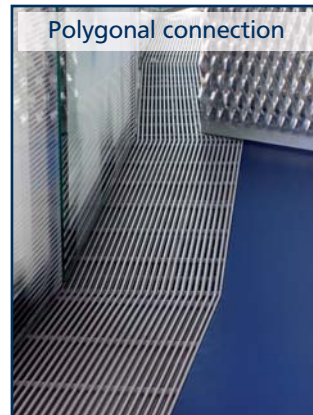
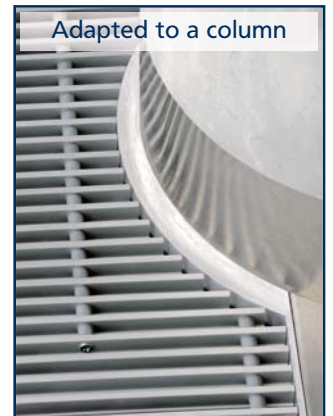

“Optiline” roll-up grilles

Ultra-elegant narrow-spaced air outlets

- Exceptional appearance thanks to narrow bar spacing, with 65 % free area
- Available in a range of different materials and designs
- “Optiline” has the right grille for every application

Find Kampmann “Optiline” roll-up grilles in

Foreign Office, Bonn • Trade Fair Centre Forum, Frankfurt/Main • Euro Plaza, Vienna

Quick-Info

Scanning,
decoding,
using mobile content



Aluminium, natural anodised E6/EV1

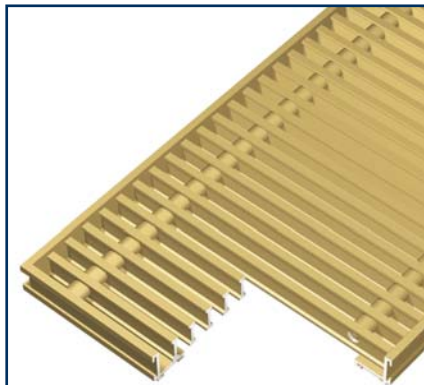

Aluminium, brass anodised E6/EV3



Aluminium, painted DB703



Aluminium, bronze finish E6/C31

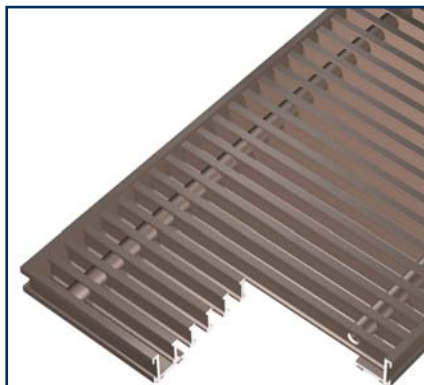

Aluminium, bronze anodised E6/C34



Aluminium, painted white

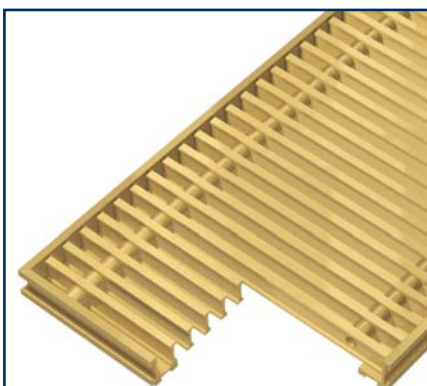

Brass, natural CuZn 44



Stainless steel



Stainless steel, polished

The colours of the grilles shown here are not exact replicas of the actual colours and may differ from the actual colours due to the printing.

“Optiline” roll-up grilles

Ultra-elegant narrow-spaced air outlets

“Optiline” roll-up grilles

Connections	corrosion-proof steel coil springs with spacers in a matching colour													
Dimensions of bar profile	mm	18 x 5 (aluminium, brass); 18 x 6 (stainless steel)												
Dimensions of frame profile	mm	25 x 25 x 5 (aluminium); 25 x 21 x 5 (brass); 22 x 19 x 3 (stainless steel)												
Free area	approx. 65 %													
Overall frame length L	calculated from clear trench length + 50 mm (tolerance ± 10 mm)													
Overall frame width A ¹⁾	mm	200	250	290	300	350	370	400	450	500	530	550	600	610
Duct width B	mm	150	200	240	250	300	320	350	400	450	480	500	550	560
Roll-up grille bar width C	mm	188	238	278	288	338	358	388	438	488	518	538	588	598
Width key		00	01	02	03	04	05	06	07	08	09	10	11	12
“Optiline” roll-up grilles	Art.-No.	Frame										Art.-No.		
Aluminium, natural anodised E6/EV1	1300004270_*_	Aluminium, natural anodised E6/EV1										1300006225_*_		
Aluminium, brass anodised E6/EV3	1300004570_*_	Aluminium, brass anodised E6/EV3										1300006525_*_		
Aluminium, bronze anodised E6/C34	1300004070_*_	Aluminium, bronze anodised E6/C34										1300006025_*_		
Aluminium, bronze finish E6/C31	1300004870_*_	Aluminium, bronze finish E6/C31										1300006825_*_		
Aluminium, painted DB703	1300004370_*_	Aluminium, painted DB703										1300006625_*_		
Aluminium, painted white	1300004470_*_	Aluminium, painted white										1300006425_*_		
Brass, natural CuZn 44	1300004170_*_	Brass, natural CuZn 44										1300008125_*_		
Overall frame width A ¹⁾	mm	200	250	290	300	350	370	400	450	500	530	550	600	610
Duct width B	mm	150	200	240	250	300	320	350	400	450	480	500	550	560
Roll-up grille bar width C	mm	192	242	282	292	342	362	392	442	492	522	542	592	602
Width key		00	01	02	03	04	05	06	07	08	09	10	11	12
“Optiline” roll-up grilles	Art.-No.	Frame										Art.-No.		
Stainless steel	1300004675_*_	Stainless steel										1300005222_*_		
Stainless steel, polished	1300004775_*_	Stainless steel										1300005222_*_		

* Insert width key

¹⁾ Intermediate dimensions possible

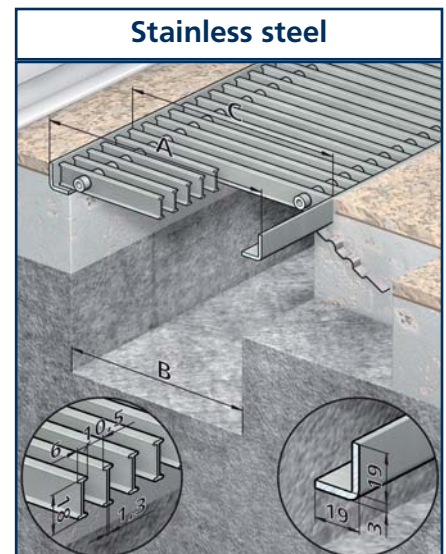
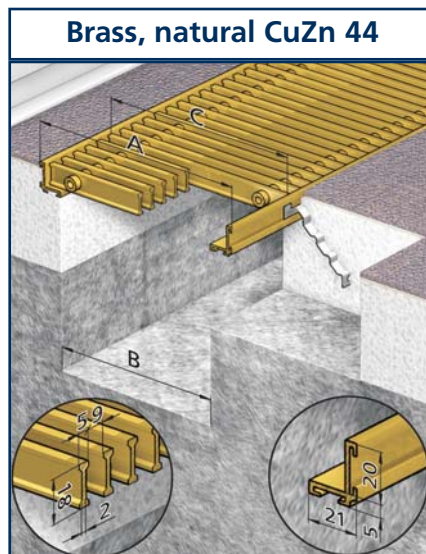
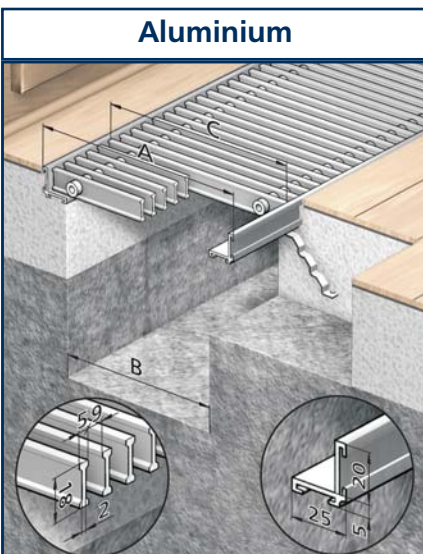

The colours of the grilles shown here are not exact replicas of the actual colours and may differ from the actual colours due to the printing.

Aluminium roll-up grilles

The sophisticated "all rounder"

- Made from anodised aluminium, available in four colours
- For residential properties, salesrooms, industrial and commercial buildings
- Available in two bar spacings

Quick-Info

Scanning,
decoding,
using mobile content



Find Kampmann anodised aluminium roll-up grilles in:

New Exhibition Centre, Munich • Hackescher Market, Berlin • World Port Centre, Rotterdam

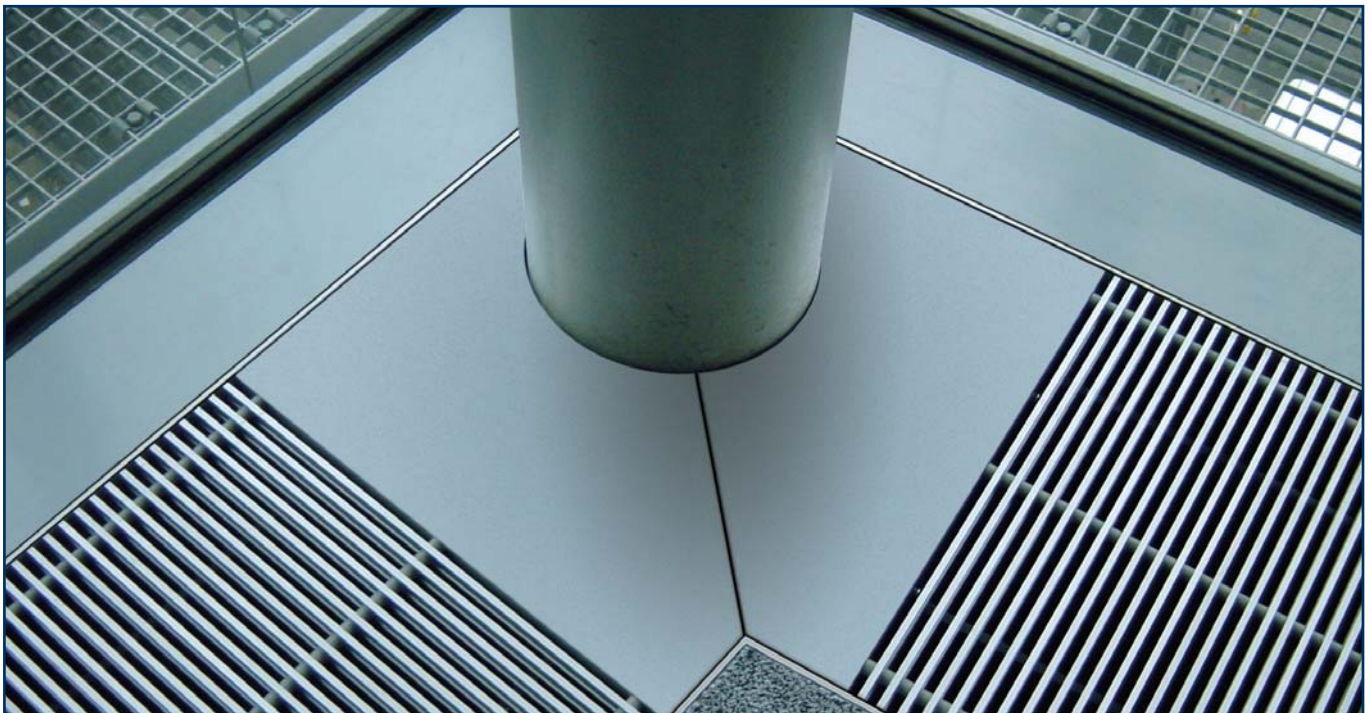

Aluminium roll-up grilles

The sophisticated "all rounder"

Aluminium roll-up grilles

Connections	corrosion-proof steel coil springs with spacers in a matching colour																
Dimensions of bar profile	mm	19,5 x 8															
Dimensions of frame profile	mm	25 x 25 x 5															
Overall frame length L	calculated from clear trench length + 50 mm (tolerance ± 10 mm)																
Overall frame width A ¹⁾	mm	200	250	290	300	350	370	400	450	500	530	550	600	610	650	700	750
Duct width B	mm	150	200	240	250	300	320	350	400	450	480	500	550	560	600	650	700
Roll-up grille bar width C	mm	188	238	278	288	338	358	388	438	488	518	538	588	598	638	688	738
Width key		00	01	02	03	04	05	06	07	08	09	10	11	12	13	14	15
Aluminium roll-up grilles		Free area			Art.-No.			Frame						Art.-No.			
Aluminium, natural anodised E6/EV1		approx. 70 %			1300006270_*			Aluminium, natural anodised E6/EV1						1300006225_*			
		approx. 60 %			1300006260_*												
Aluminium, brass anodised E6/EV3		approx. 70 %			1300006570_*			Aluminium, brass anodised E6/EV3						1300006525_*			
		approx. 60 %			1300006560_*												
Aluminium, bronze anodised E6/C34		approx. 70 %			1300006070_*			Aluminium, bronze anodised E6/C34						1300006025_*			
		approx. 60 %			1300006060_*												
Aluminium, bronze finish E6/C31		approx. 70 %			1300006870_*			Aluminium, bronze finish E6/C31						1300006825_*			
		approx. 60 %			1300006860_*												

* Insert width key

¹⁾ Intermediate dimensions possible

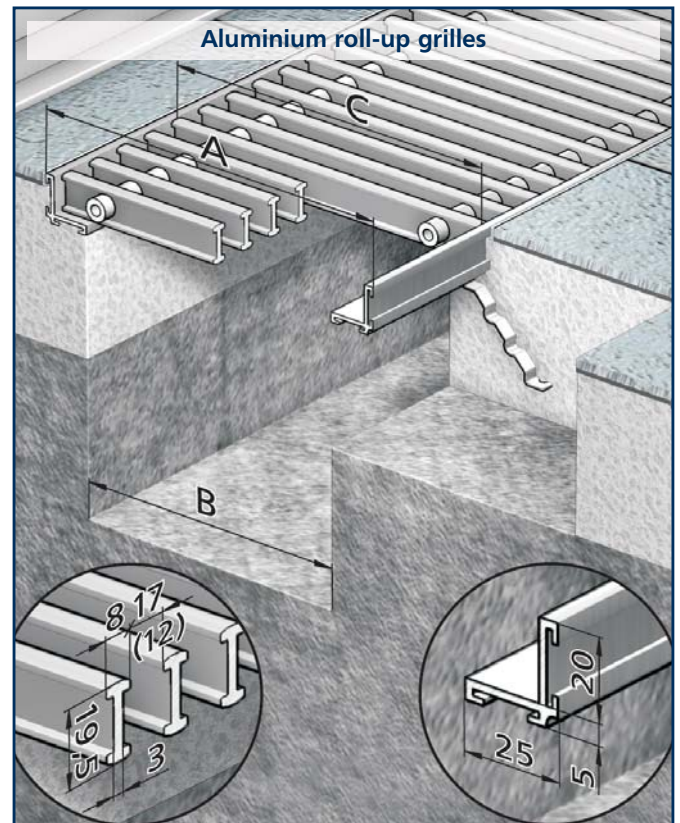

The colours of the grilles shown here are not exact replicas of the actual colours and may differ from the actual colours due to the printing.

Keyline Roll-up Grilles

Designer grilles

Designer grilles for perfect visual and functional integration into modern premium rooms and offices.

Made of anodised aluminium, Keyline roll-up grilles are available in four colours: natural anodised, brass anodised, bronze finish, bronze anodised. Matching frames are available for each colour.

Quick-Info

Scanning,
decoding,
using mobile content

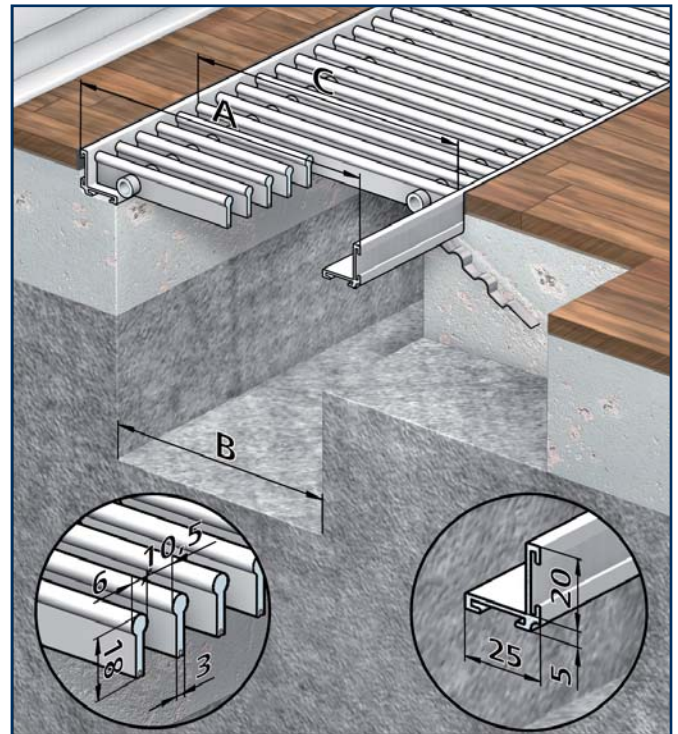

The colours of the grilles shown here are not exact replicas of the actual colours and may differ from the actual colours due to the printing.

Keyline roll-up grilles – creating a new benchmark in designer grilles

Connections	corrosion-proof steel coil springs with spacers in a matching colour									
Dimensions of bar profile	mm	18 x 6								
Dimensions of frame profile	mm	25 x 25 x 5								
Free area	approx. 64 %									
Overall frame length L	calculated from clear trench length + 50 mm (tolerance ± 10 mm)									
Overall frame width A ¹⁾	mm	200	250	290	300	350	370	400	450	
Duct width B	mm	150	200	240	250	300	320	350	400	
Roll-up grille bar width C	mm	188	238	278	288	338	358	388	438	
Width key		00	01	02	03	04	05	06	07	
Roll-Rost Keyline	Art.-No.	Frame						Art.-No.		
Aluminium, natural anodised E6/EV1	1300017265_*	Aluminium, natural anodised E6/EV1						1300006225_*		
Aluminium, brass anodised E6/EV3	1300017565_*	Aluminium, brass anodised E6/EV3						1300006525_*		
Aluminium, bronze anodised E6/C34	1300017065_*	Aluminium, bronze anodised E6/C34						1300006025_*		
Aluminium, bronze finish E6/C31	1300017865_*	Aluminium, bronze finish E6/C31						1300006825_*		

* Insert width key

¹⁾ Intermediate dimensions possible

Brass roll-up grilles

The sophisticated grilles

- Made of pure brass CuZn 37
- Available with two bar spacings
- For up-market residential and office properties

Quick-Info

Scanning,
decoding,
using mobile content



Find Kampmann brass roll-up grilles in

Fürstenhof, Frankfurt/Main • Palais Coburg, Vienna • Hotel Nordperle, Rügen

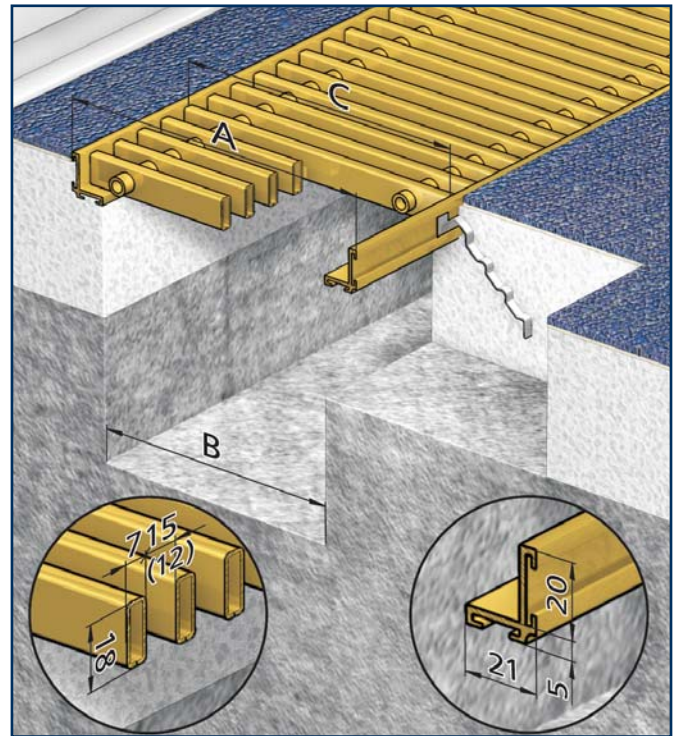

The colours of the grilles shown here are not exact replicas of the actual colours and may differ from the actual colours due to the printing.

Brass roll-up grilles																	
Connections	corrosion-proof steel coil springs with spacers in a matching colour																
Dimensions of bar profile	mm	18 x 7															
Dimensions of frame profile	mm	25 x 21 x 5															
Overall frame length L	calculated from clear trench length + 50 mm (tolerance + - 10 mm)																
Overall frame width A ¹⁾	mm	200	250	290	300	350	370	400	450	500	530	550	600	610	650	700	750
Duct width B	mm	150	200	240	250	300	320	350	400	450	480	500	550	560	600	650	700
Roll-up grille bar width C	mm	188	238	278	288	338	358	388	438	488	518	538	588	598	638	688	738
Width key		00	01	02	03	04	05	06	07	08	09	10	11	12	13	14	15
Brass roll-up grilles		Free area					Art.-No.			Frame				Art.-No.			
Natural brass CuZn 37		approx. 70 %					1300008270 _*			Brass, natural CuZn 37				1300008125 _*			
		approx. 60 %					1300008260 _*										

* Insert width key

¹⁾ Intermediate dimensions possible

Stainless steel roll-up grilles

Contemporary and functional

- Made of stainless steel, also available as a polished grille
- Available in two profile shapes
- Ideal for use in residential properties and offices

Quick-Info

Scanning,
decoding,
using mobile content



Find Kampmann stainless steel roll-up grilles in:

Hotel Interconti, Berlin • BMW World, Munich • Chase-Manhattan Forum, Frankfurt

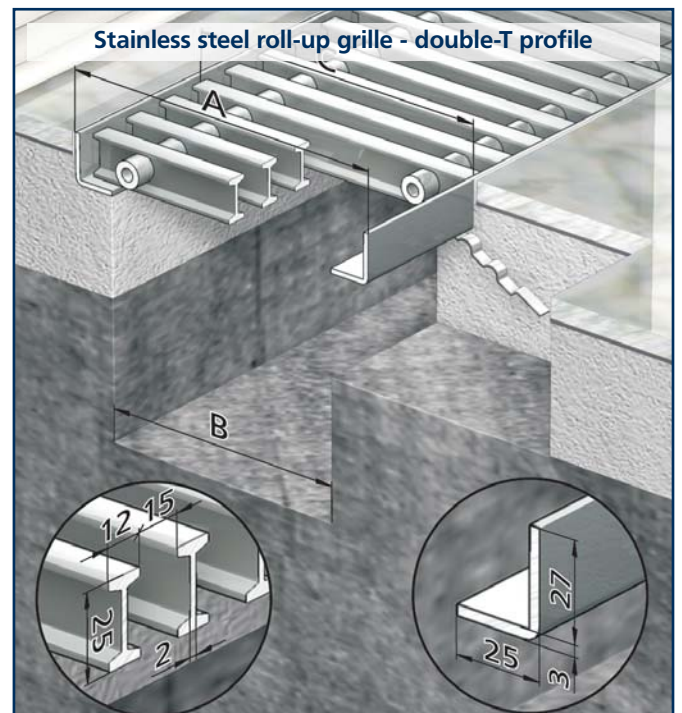
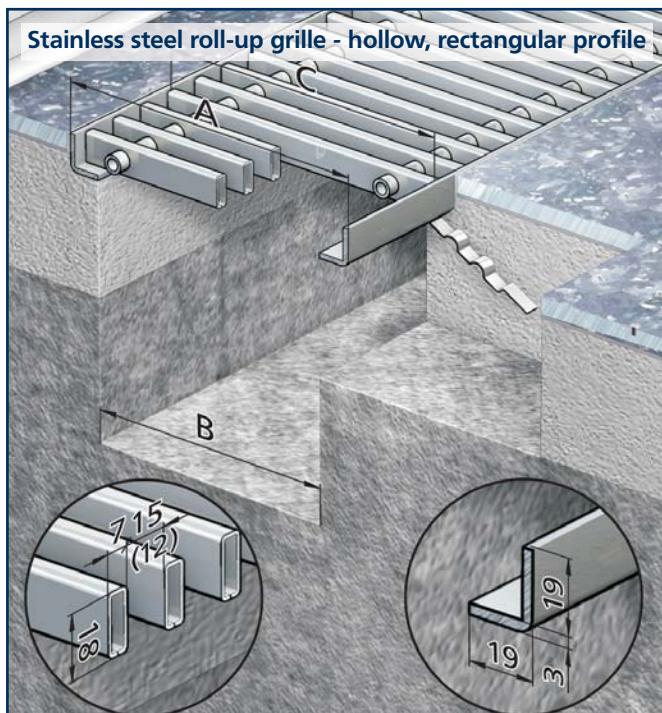

The colours of the grilles shown here are not exact replicas of the actual colours and may differ from the actual colours due to the printing.

Stainless steel roll-up grilles

Contemporary and functional

Stainless steel roll-up grilles, hollow, rectangular profile

Connections	corrosion-proof steel coil springs with spacers in a matching colour																
Dimensions of bar profile	mm	18 x 7															
Dimensions of frame profile	mm	22 x 19 x 3															
Overall frame length L	calculated from clear trench length + 50 mm (tolerance ± 10 mm)																
Overall frame width A ¹⁾	mm	200	250	290	300	350	370	400	450	500	530	550	600	610	650	700	750
Duct width B	mm	150	200	240	250	300	320	350	400	450	480	500	550	560	600	650	700
Roll-up grille bar width C	mm	192	242	282	292	342	362	392	442	492	522	542	592	602	642	692	742
Width key		00	01	02	03	04	05	06	07	08	09	10	11	12	13	14	15
Stainless steel roll-up grilles		Free area			Art.-No.			Frame						Art.-No.			
Stainless steel, hollow, rectangular profile		approx. 70 %			1300005370			Stainless steel						1300005320			
		approx. 60 %			1300005360												



The colours of the grilles shown here are not exact replicas of the actual colours and may differ from the actual colours due to the printing.

Stainless steel roll-up grilles, double-T profile

Connections	Stainless steel coil springs with spacers in a matching colour																
Dimensions of bar profile	mm	25 x 12															
Dimensions of frame profile	mm	30 x 25 x 3															
Free area	approx. 55 %																
Overall frame length L	calculated from clear trench length + 50 mm (tolerance + - 10 mm)																
Outer frame width A ¹⁾	mm	200	250	290	300	350	370	400	450	500	530	550	600	610			
Duct width B	mm	150	200	240	250	300	320	350	400	450	480	500	550	560			
Roll-up grille bar width C	mm	192	242	282	292	342	362	392	442	492	522	542	592	602			
Width key		00	01	02	03	04	05	06	07	08	09	10	11	12			
Stainless steel roll-up grilles		Art.-No.			Frame						Art.-No.						
Stainless steel, double-T profile		1300003270			Stainless steel						1300003227						
Polished stainless steel, double-T profile		1300003770			Stainless steel						1300003227						

* Insert width key

¹⁾ Intermediate dimensions possible

Wooden roll-up grilles

Warm and homely - decorative wooden covers

- Currently wooden grilles are available in four types of wood, either varnished or oiled
- For a warm and homely feel in residential properties and offices

Quick-Info

Scanning,
decoding,
using mobile content



Find Kampmann wooden roll-up grilles in:

- Hotel Adlon, Berlin • Kühne und Nagel Centre, Hamburg

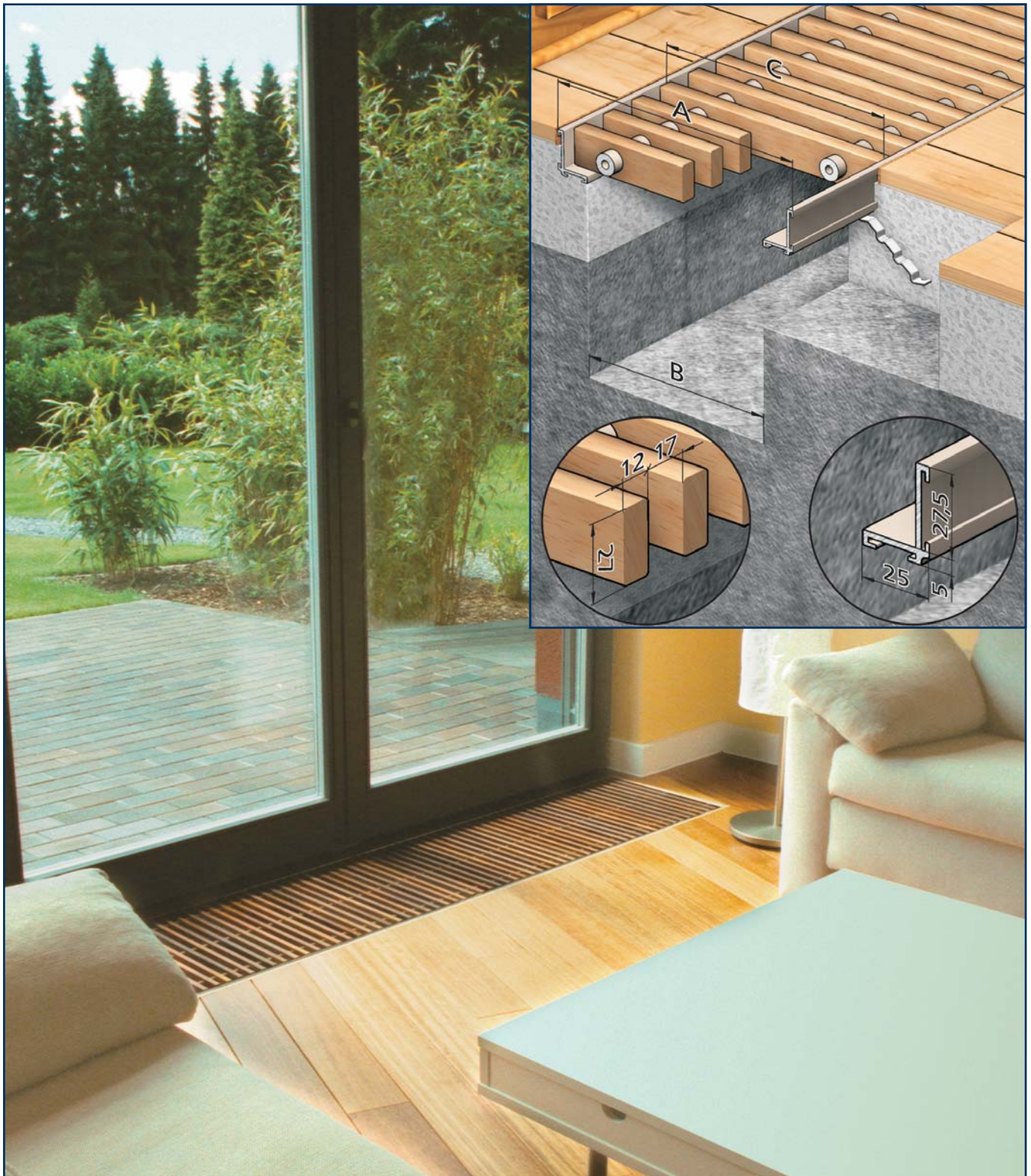

Wooden roll-up grilles

Warm and homely - decorative wooden covers

Wooden roll-up grilles

Connections	corrosion-proof steel coil springs with spacers in a matching colour								
Dimensions of bar profile	mm	27 x 12							
Dimensions of frame profile	mm	32,5 x 25 x 5							
Free area	approx. 60 %								
Overall frame length L	calculated from clear trench length + 50 mm (tolerance + - 10 mm)								
Overall frame width A ¹⁾	mm	200	250	290	300	350	370	400	450
Duct width B	mm	150	200	240	250	300	320	350	400
Roll-up grille bar width C	mm	188	238	278	288	338	358	388	438
Width key		00	01	02	03	04	05	06	07
Wooden roll-up grilles	Art.-No.	Wooden roll-up grilles				Art.-No.			
Natural oak, varnished	1300001155_*_	Oiled oak				1300001156_*_			
Natural beech, varnished	1300001255_*_	Oiled beech				1300001256_*_			
Natural maple, varnished	1300001355_*_	Oiled maple				1300001356_*_			
Natural merbau, varnished	1300001455_*_	Oiled merbau				1300001456_*_			
Frame	Art.-No.	Frame				Art.-No.			
Aluminium, natural anodised E6/EV1	1300009225_*_	Aluminium, brass anodised E6/EV3				1300009525_*_			
Aluminium, bronze anodised E6/C34	1300009025_*_	Aluminium, bronze finish E6/C31				1300009825_*_			

* Insert width key

¹⁾ Intermediate dimensions possible

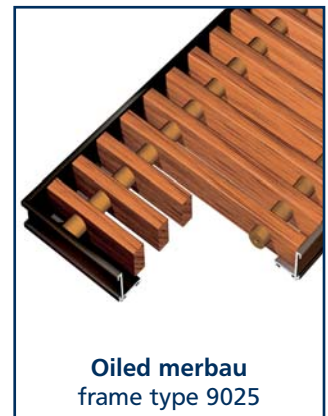
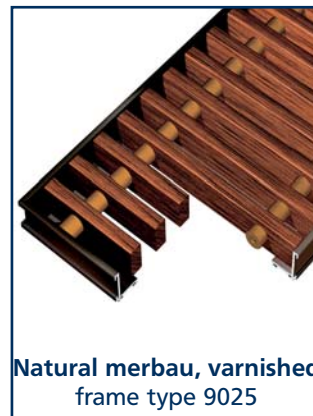

Wood is a natural product and therefore deviations and differences in colour may occur.

The colours of the grilles shown here are not exact replicas of the actual colours and may differ from the actual colours due to the printing.

Kampmann.de _____ Phone +44 1932 228592

Kampmann. Genau mein Klima.
KAMPMANN

Linear Grilles

Decorative covers for air outlets - cannot be walked upon

Linear grilles, anodised aluminium				Frames in anodised aluminium			
Model	Dimensions of bar profile 18 x 5 x 1,5 mm	Type	Colour	Type	Colour	Frame profile	Dimensions of frame profile
		3170	natural	3119	natural	L-profile	20 x 20 x 2 mm
				3120	natural	Z-profile	20 x 19 x 1,5 mm
				3130	natural	ZU-profile	30 x 20 x 1,5 mm
		3570	brass	3519	brass	L-profile	20 x 20 x 2 mm
				3520	brass	Z-profile	20 x 19 x 1,5 mm
				3530	brass	ZU-profile	30 x 20 x 1,5 mm
		3070	bronze	3019	bronze	L-profile	20 x 20 x 2 mm
				3020	bronze	Z-profile	20 x 19 x 1,5 mm
				3030	bronze	ZU-profile	30 x 20 x 1,5 mm
		3370	black	3319	black	L-profile	20 x 20 x 2 mm
				3320	black	Z-profile	20 x 19 x 1,5 mm
				3330	black	ZU-profile	30 x 20 x 1,5 mm

Frame variations

L-frame		Z-frame		ZU-frame
L-frame profile 20 x 20 x 2 mm		Z-frame profile 20 x 19 x 1,5 mm		ZU-frame profile 30 x 20 x 1,5 mm
Fixing method A	Fixing method B	Fixing method A	Fixing method B	Fixing method A
L-profile frame, type 3119, 3519, 3019, 3319. For horizontal installation. The grille is inserted loosely and easy to remove. Vertical installation only in combination with a fixing clip (available at a supplement).		Z-profile frame, type 3120, 3520, 3020, 3320. For horizontal installation. The grille is inserted loosely and easy to remove. Vertical installation only in combination with a fixing clip (available at a supplement).		ZU-profile frame, type 3130, 3530, 3030, 3330. For horizontal or vertical installation. Suitable as continuous grille edging. The grille is integrated into the frame

Measurement chart for standard dimensions

Opening width	mm	A	68	84	100	116	148	180	212	244	276	308
Grille width	mm	C	62	78	94	110	142	174	206	238	270	302
Frame width with L-frames	mm	B	67	83	99	115	147	179	211	243	275	307
Frame width with Z- and ZU-frames	mm	D	103	119	135	151	183	215	247	279	311	343
Opening length	mm	L	Please specify when ordering									
Grille length		G	L-6 mm	Frame length with L-frames L-2 mm Frame length with Z- and ZU-frames L+35 mm								

Important order information for all grilles

Grilles without a frame

Colour: Type
 Grille bar width = C mm
 (at least 2 mm shorter than E) C mm
 *Grille length = L mm (should be specified
 as a frame dimension, such as E) L mm

Grilles with a frame

Colour: Type
 Overall frame width = A mm
 Overall frame length = L mm

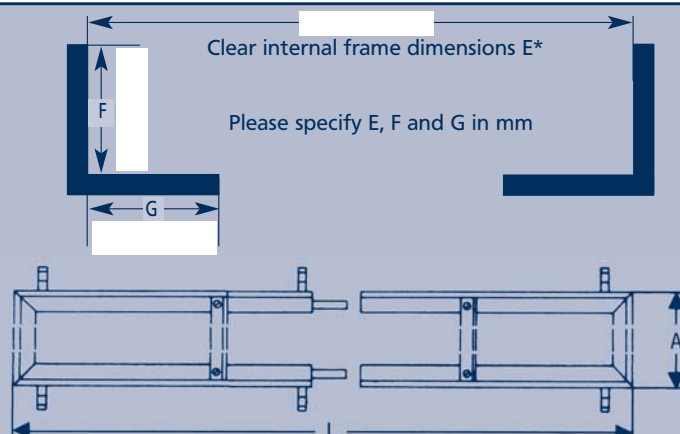

Special frames

Type	Material	Colour/surface	Frame in mm	Bar height in mm		Angle dimensions in mm		
				H	I	J	K	
6025	Aluminium	bronze	25 x 25 x 5	18/19,5	25	25	5	
6225	Aluminium	natural	25 x 25 x 5	18/19,5	25	25	5	
6425	Aluminium	white	25 x 25 x 5	18	25	25	5	
6525	Aluminium	brass	25 x 25 x 5	18/19,5	25	25	5	
6625	Aluminium	painting DB 703	25 x 25 x 5	18	25	25	5	
6825	Aluminium	bronze finish	25 x 25 x 5	18/19,5	25	25	5	
8125	Brass	natural	25 x 21 x 5	18	25	21	5	
9025	Aluminium	bronze	32,5 x 25 x 5	18*	32,5	25	5	
9225	Aluminium	natural	32,5 x 25 x 5	18*	32,5	25	5	
9525	Aluminium	brass	32,5 x 25 x 5	18*	32,5	25	5	
9825	Aluminium	bronze finish	32,5 x 25 x 5	18*	32,5	25	5	

* Dimensions of bar profile without comb profile

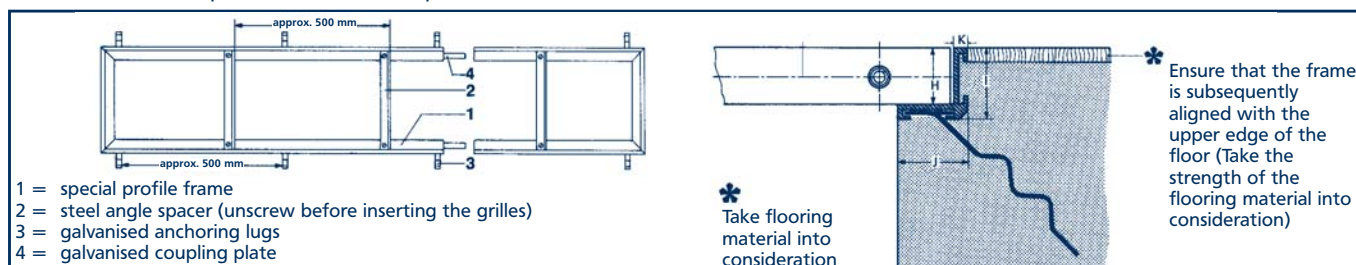

Angle frames

Type	Material	Colour/surface	Frame in mm	Bar height in mm		Angle dimensions in mm		
				H	I	J	K	
5320	Stainless steel	natural	22 x 19 x 3	18	22	19	3	
3227	Stainless steel	natural	30 x 25 x 3	25	30	25	3	
5222	Stainless steel	natural	22 x 19 x 3	18	22	19	3	

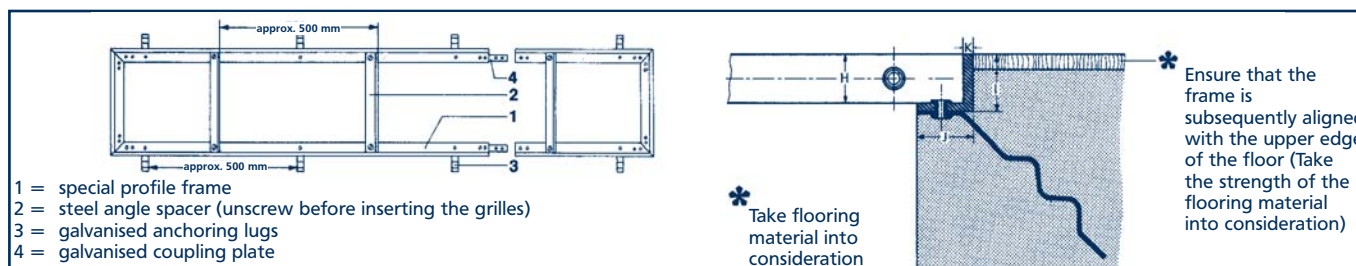

All special frames and angle frames are delivered fully assembled with stainless steel anchoring lugs and steel angle spacers already screwed in. Frame lengths above approx. 3 m are separated for transport. The parts can be quickly and easily assembled using coupling plates that are attached to the joints.

Roll-up Grilles • Linear Grilles

Overview of grille and frame types

Grilles				Frames		
Type	Model/Colour	Free area	Bar profile	Type	Model/Colour	Frame profile
Aluminium roll-up grilles				Aluminium, anodised		
6270	Aluminium, natural anodised E6/EV1	approx. 70 %	19,5 x 8 mm	6225	natural anodised E6/EV1	25 x 25 x 5 mm
6570	Aluminium, brass anodised E6/EV3			6525	brass anodised E6/EV3	
6070	Aluminium, bronze anodised E6/C34			6025	bronze anodised E6/C34	
6870	Aluminium, bronze finish E6/C31			6825	bronze finish E6/C31	
6260	Aluminium, natural anodised E6/EV1	approx. 60 %	19,5 x 8 mm	6225	natural anodised E6/EV1	25 x 25 x 5 mm
6560	Aluminium, brass anodised E6/EV3			6525	brass anodised E6/EV3	
6060	Aluminium, bronze anodised E6/C34			6025	bronze anodised E6/C34	
6860	Aluminium, bronze finish E6/C31			6825	bronze finish E6/C31	
Brass roll-up grilles				Natural brass		
8270	Brass, natural CuZn 37	approx. 70 %	18 x 7 mm	8125	Brass, natural CuZn 37	25 x 21 x 5 mm
8260	Brass, natural CuZn 37	approx. 60 %		8125	Brass, natural CuZn 37	
Stainless Steel Roll-up Grilles				Stainless steel		
3270	Stainless steel	approx. 55 %	25 x 12 mm	3227	Stainless steel	30 x 25 x 3 mm
3770	Stainless steel, polished					
5370	Stainless steel	approx. 70 %	18 x 7 mm	5320	Stainless steel	22 x 19 x 3 mm
5360	Stainless steel	approx. 60 %				
Optiline roll-up grilles				Aluminium, anodised		
4270	Aluminium, natural anodised E6/EV1	approx. 65 %	18 x 5 mm	6225	natural anodised E6/EV1	25 x 25 x 5 mm
4570	Aluminium, brass anodised E6/EV3			6525	brass anodised E6/EV3	
4070	Aluminium, bronze anodised E6/C34			6025	bronze anodised E6/C34	
4870	Aluminium, bronze finish E6/C31			6825	bronze finish E6/C31	
4370	Aluminium, painted DB703			6625	painted DB703	
4470	Aluminium, painted white			6425	painted white	
4170	Brass, natural, CuZn 44	approx. 65 %	18 x 5 mm	8125	Brass, natural, CuZn 44	25 x 21 x 5 mm
4675	Stainless steel	approx. 65 %	18 x 6 mm	5222	Stainless steel	22 x 19 x 3 mm
4775	Stainless steel, polished					
Keyline roll-up grilles				Aluminium, anodised		
17265	Aluminium, natural anodised E6/EV1	approx. 64 %		6225	natural anodised E6/EV1	25 x 25 x 5 mm
17565	Aluminium, brass anodised E6/EV3			6525	brass anodised E6/EV3	
17065	Aluminium, bronze anodised E6/C34			6025	bronze anodised E6/C34	
17865	Aluminium, bronze finish E6/C31			6825	bronze finish E6/C31	
Wooden roll-up grilles				Aluminium, anodised		
1155	Natural oak, varnished	approx. 60 %	27 x 12 mm	9225	natural anodised E6/EV1	32,5 x 25 x 5 mm
1156	Oiled oak			9525	brass anodised E6/EV3	
1255	Natural beech, varnished					
1256	Oiled beech			9025	bronze anodised E6/C34	
1355	Natural maple, varnished					
1356	Oiled maple			9825	bronze finish E6/C31	
1455	Natural merbau, varnished					
1456	Oiled merbau					

Quantity	Article No.	Description
m	1300004_70_*	<p>Optiline roll-up grille, anodised aluminium</p> <p>Attractive, narrow-spaced air outlets for underfloor convectors made of an anodised aluminium, double-T profile. Connections made of corrosion-proof steel coil springs, with spacers in a matching colour. Free area approx. 65% Bar dimensions: 18 x 5 mm Roll-up grille bar width: C = <input type="text"/> mm</p> <p>Finish</p> <ul style="list-style-type: none"> 0 Aluminium, bronze anodised E6/C34 2 Aluminium, natural anodised E6/EV1 3 Aluminium, painted DB 703 4 Aluminium, painted white 5 Aluminium, brass anodised E6/EV3 8 Aluminium, bronze finish E6/C31 <p>Manufactured by Kampmann, art.no. 1300004_70_ __, Type 4_70_ __</p>
m	1300004170_*	<p>Optiline roll-up grille, natural brass CuZn44</p> <p>Attractive narrow-spaced air outlets for underfloor convectors made of a natural brass CuZn44, double-T profile. Connections made of corrosion-proof steel coil springs, with spacers in a matching colour. Free area approx. 65% Bar dimensions: 18 x 5 mm Roll-up grille bar width: C = <input type="text"/> mm</p> <p>Finish</p> <p>Brass, natural CuZn 44</p> <p>Manufactured by Kampmann, art.no. 1300004170_ __, Type 4170_ __</p>
m	1300004_75_*	<p>Optiline roll-up grille, stainless steel</p> <p>Attractive narrow-spaced air outlets for underfloor convectors made of a stainless steel, double-T profile. Connections made of corrosion-proof steel coil springs, with spacers in a matching colour. Free area approx. 65% Bar dimensions: 18 x 6 mm Roll-up grille bar width: C = <input type="text"/> mm</p> <p>Finish</p> <ul style="list-style-type: none"> 6 Stainless steel 7 Stainless steel, polished <p>Manufactured by Kampmann, art.no. 1300004_75_ __, Type 4_75_ __</p>
m	130000_*	<p>Roll-up frame</p> <p>for Optiline roll-up grilles made of an: aluminium frame profile 25 x 25 x 5 mm brass frame profile 25 x 21 x 5 mm stainless steel frame profile 22 x 19 x 3 mm with anchoring lugs, tabs and installation spacers Overall frame width: A = <input type="text"/> mm</p> <p>Finish</p> <ul style="list-style-type: none"> 6025 Aluminium, bronze anodised E6/C34 6225 Aluminium, natural anodised E6/EV1 6425 Aluminium, painted white 6525 Aluminium, brass anodised E6/EV3 6625 Aluminium, painted DB 703 6825 Aluminium, bronze finish E6/C31 8125 Brass, natural CuZn 44 5222 Stainless steel <p>Manufactured by Kampmann, art.no. 130000_ ____, Type _ __</p>

* Insert width key

Aluminium Roll-up Grilles • Brass Roll-up Grilles

Specifications

Quantity	Article No.	Description
m	1300006_70_* _ _	<p>Aluminium roll-up grille Decorative air outlets for underfloor convectors made of an anodised aluminium, double-T profile. Connections made of corrosion-proof steel coil springs, with spacers in a matching colour. Free area approx. 70%, Bar dimensions: 19.5 x 8 mm Roll-up grille bar width: C = <input type="text"/> mm</p> <p>Finish 0 Aluminium, bronze anodised E6/C34 2 Aluminium, natural anodised E6/EV1 5 Aluminium, brass anodised E6/EV3 8 Aluminium, bronze finish E6/C31</p> <p>Manufactured by Kampmann, art.no. 1300006_70_ __, Type 6_70_ __</p>
m	1300006_60_* _ _	<p>Aluminium roll-up grille Decorative air outlets for underfloor convectors made of an anodised aluminium, double-T profile. Connections made of corrosion-proof steel coil springs, with spacers in a matching colour. Free area approx. 60 %, Bar dimensions: 19.5 x 8 mm Roll-up grille bar width: C = <input type="text"/> mm</p> <p>Finish 0 Aluminium, bronze anodised E6/C34 2 Aluminium, natural anodised E6/EV1 5 Aluminium, brass anodised E6/EV3 8 Aluminium, bronze finish E6/C31</p> <p>Manufactured by Kampmann, art.no. 1300006_60_ __, Type 6_60_ __</p>
m	1300006_25_* _ _	<p>Roll-up grille frame for anodised aluminium roll-up grilles, made of an aluminium frame profile 25 x 25 x 5 mm, movable, galvanised anchoring lugs, with installation spacers, mitred end edges, anodised in a colour matching the roll-up grilles. Overall frame width: A = <input type="text"/> mm</p> <p>Finish 0 Aluminium, bronze anodised E6/C34 2 Aluminium, natural anodised E6/EV1 5 Aluminium, brass anodised E6/EV3 8 Aluminium, bronze finish E6/C31</p> <p>Manufactured by Kampmann, art.no. 1300006_25_ __, Type 6_25_ __</p>
m	1300008270_* _ _	<p>Brass roll-up grille Decorative air outlets for underfloor convectors made of a natural brass, CuZn 37, rectangular open-seam tube profile. Connections made of corrosion-proof steel coil springs, with spacers in a matching colour. Free area approx. 70%, Bar dimensions: 18 x 7 mm Roll-up grille bar width: C = <input type="text"/> mm</p> <p>Finish Brass, natural CuZn 37</p> <p>Manufactured by Kampmann, art.no. 1300008270_ __, Type 8270_ __</p>
m	1300008260_* _ _	<p>Brass roll-up grille Decorative air outlets for underfloor convectors made of a natural brass, CuZn 37, rectangular open-seam tube profile. Connections made of corrosion-proof steel coil springs, with spacers in a matching colour. Free area approx. 60 %, Bar dimensions: 18 x 7 mm Roll-up grille bar width: C = <input type="text"/> mm</p> <p>Finish Brass, natural CuZn 37</p> <p>Manufactured by Kampmann, art.no. 1300008260_ __, Type 8260_ __</p>
m	1300008125_* _ _	<p>Roll-up grille frame for natural brass roll-up grilles, made of a brass, frame profile 25 x 21 x 5 mm, movable, galvanised anchoring lugs, with installation spacers. Mitred end edges. Overall frame width: A = <input type="text"/> mm</p> <p>Finish Brass, natural CuZn 37</p> <p>Manufactured by Kampmann, art.no. 1300008125_ __, Type 8125_ __</p>

* Insert width key

Stainless Steel Roll-up Grilles

Specifications

Quantity	Article No.	Description
m	1300005370 _*_	<p>Stainless steel roll-up grille Decorative air outlets for underfloor convectors made of a stainless steel, rectangular open-seam tube profile. Connections made of corrosion-proof steel coil springs, with spacers in a matching colour. Free area approx. 70% Bar dimensions: 18 x 7 mm Roll-up grille bar width: C = <input type="text"/> mm Finish Stainless steel</p> <p>Manufactured by Kampmann, art.no. 1300005370 __, Type 5370 __</p>
m	1300005360 _*_	<p>Stainless steel roll-up grille Decorative air outlets for underfloor convectors made of a stainless steel, rectangular open-seam tube profile. Connections made of corrosion-proof steel coil springs, with spacers in a matching colour. Free area approx. 60%, Bar dimensions: 18 x 7 mm Roll-up grille bar width: C = <input type="text"/> mm Finish Stainless steel</p> <p>Manufactured by Kampmann, art.no. 1300005360 __, Type 5360 __</p>
m	1300005320 _*_	<p>Roll-up grille frame for stainless steel roll-up grilles, made of a stainless steel, frame profile 22 x 19 x 3 mm, anchoring lugs and tabs made of stainless steel. With installation spacers. Overall frame width: A = <input type="text"/> mm Finish Stainless steel</p> <p>Manufactured by Kampmann, art.no. 1300005320 __, Type 5320 __</p>
m	1300003_70_*_	<p>Stainless steel roll-up grille Decorative air outlets for underfloor convectors made of a stainless steel, double-T profile, connections made of stainless steel coil springs, with stainless steel spacers. Free area approx. 55%, Bar dimensions: 25 x 12 mm Roll-up grille bar width: C = <input type="text"/> mm Finish 2 Stainless steel 7 polished stainless steel</p> <p>Manufactured by Kampmann, art.no. 1300003_70 __, Type 3_70 __</p>
m	1300003227 _*_	<p>Roll-up grille frame stainless steel roll-up grilles, made of a stainless steel, frame profile 30 x 25 x 3 mm, anchoring lugs and tabs made of stainless steel. With installation spacers. Overall frame width: A = <input type="text"/> mm Finish Stainless steel</p> <p>Manufactured by Kampmann, art.no. 1300003227 __, Type 3227 __</p>

* Insert width key

Keyline Roll-up Grilles • Wooden Roll-up Grilles

Specifications

Quantity	Article No.	Description
m	1300017_65_*	<p>Keyline roll-up grille in a rounded design as a droplet-shaped profile, made of anodised aluminium. Connections made of corrosion-proof steel coil springs with spacers in a matching colour. Reduced view into the duct due to shadowing on the edge of the profile. Free area 64 %, bar dimensions: 18 x 6 mm. Fabricated by hand for a perfect fit.</p> <p>Finish 2 Aluminium, natural anodised E6/EV1 5 Aluminium, brass anodised E6/EV3 0 Aluminium, bronze anodised E6/C34 8 Aluminium, bronze finish E6/C31</p> <p>Manufactured by Kampmann, art.no. 1300017_65___, Type 17_65___</p>
m	1300006_25_*	<p>Grille frame for Keyline, made of an aluminium frame profile 25 x 25 x 5 mm. Movable, galvanised anchoring lugs. With installation spacers. mitred end edges. Anodised in a colour matching the roll-up grilles. Overall frame width: A = <input type="text"/> mm</p> <p>Finish 0 Aluminium, bronze anodised E6/C34 2 Aluminium, natural anodised E6/EV1 5 Aluminium, brass anodised E6/EV3 8 Aluminium, bronze finish E6/C31</p> <p>Manufactured by Kampmann, art.no. 1300006_25___, Type 6_25___</p>
m	130000_ ____*	<p>Wooden roll-up grille made of a solid wooden profile. Connections made of corrosion-proof steel coil springs, with spacers, pearl beige colour. Free area approx. 60% Bar dimensions: 27 x 12 mm Roll-up grille bar width: C = <input type="text"/> mm</p> <p>Finish 1155 Natural oak, varnished 1156 Oiled oak 1255 Natural beech, varnished 1256 Oiled beech 1355 Natural maple, varnished 1356 Oiled maple 1455 Natural merbau, varnished 1456 Oiled merbau</p> <p>Manufactured by Kampmann, art.no. 1300001_5___, Type 1_5 ___</p>
m	1300009_25_*	<p>Roll-up grille frame for wooden roll-up grilles, made of an aluminium frame profile 32.5 x 25 x 5 mm. Movable, galvanised anchoring lugs. With installation spacers. Mitred end edges. Overall frame width: A = <input type="text"/> mm</p> <p>Finish 2 Aluminium, natural anodised E6/EV1 5 Aluminium, brass anodised E6/EV3 0 Aluminium, bronze anodised E6/C34 8 Aluminium, bronze finish E6/C31</p> <p>Manufactured by Kampmann, art.no. 1300009_25___, Type 9_25___</p>

* Insert width key

Quantity	Article No.	Description
m	130000003_70	<p>Linear Grilles cannot be walked upon, parallel air outlet grilles made anodised aluminium with a streamlined droplet-shaped profile. Rigid connections. Free area approx. 68 %, bar dimensions: 18 x 5 (1.5) mm. Linear grille width: B = <input type="text"/> mm</p> <p>Finish 1 Aluminium, natural anodised 5 Aluminium, brass anodised 0 Aluminium, bronze anodised 3 Aluminium, black anodised</p> <p>Manufactured by Kampmann, art.no. 130000003_70, Type 3_70</p>
m	130000003_19	<p>Linear grille frame anodised aluminium, made of an anodised aluminium L-profile 20 x 20 x 2 mm. Anodised in a colour matching the linear grilles. Fixing method <input type="text"/></p> <p>Finish 1 Aluminium, natural anodised 5 Aluminium, brass anodised 0 Aluminium, bronze anodised 3 Aluminium, black anodised</p> <p>Manufactured by Kampmann, art.no. 130000003_19, Type 3_19</p>
m	130000003_20	<p>Linear grille frame anodised aluminium, made of an aluminium Z-profile 20 x 19 x 1.5 mm. Anodised in a colour matching the linear grilles. Fixing method <input type="text"/></p> <p>Finish 1 Aluminium, natural anodised 5 Aluminium, brass anodised 0 Aluminium, bronze anodised 3 Aluminium, black anodised</p> <p>Manufactured by Kampmann, art.no. 130000003_20, Type 3_20</p>
m	130000003_30	<p>Linear grille frame anodised aluminium, made of an aluminium ZU-profile 30 x 20 x 1.5 mm. Anodised in a colour matching the linear grilles. Fixing method <input type="text"/></p> <p>Finish 1 Aluminium, natural anodised 5 Aluminium, brass anodised 0 Aluminium, bronze anodised 3 Aluminium, black anodised</p> <p>Manufactured by Kampmann, art.no. 130000003_30, Type 3_30</p>

* Insert width key

Your Point of Contact

Professional advice - even on-site

Kampmann systems do not just provide a comfortable, relaxing climate after installation. You can also look forward to a feel-good climate with an exclusive service at the design stage of projects. Our experts are on hand to advise and actively support you, particularly with difficult or more

complex requirements. This will allow you to quickly achieve your goal and your customers will appreciate your excellent work.

Let's discuss this in person – you will see that it is worthwhile...

Benefit from our extensive sales and marketing network for easy contact at

Kampmann.de/Beratung



Quick-Info

Scanning,
decoding,
using mobile content



Kampmann.de

Kampmann GmbH . Friedrich-Ebert-Straße 128-130 . 49811 Lingen (Ems) . Germany
Tel. +49 591 7108-0 . info@kampmann.de

Kampmann GmbH . UK Office
Dial House . Govett Avenue . Shepperton, Middlesex . TW17 8AG . UK
Tel. +44 1932 228592 . Fax +44 1932 228949
info@kampmann-uk.co.uk . www.kampmann-uk.co.uk

Keane Environmental Ltd . Kilkenny Office . Kilcross . Inistioge . Co. Kilkenny
Tel. +353 56 7758524 . Fax +353 56 7758737 . keaneenv@iol.ie

Edition 11-2011 GB

All rights reserved. Our prior permission is required for any reprints, even for excerpts.
Subject to alterations.. 328/09/11/1 GB