

Door Air Curtains

UniLine





Unbeatable advantages



UniLine at a glance



Details



Controller models



Heat output

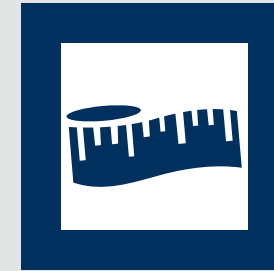

Dimensions



Benefits for you!





UniLine:
"Open doors" every day of the year now!

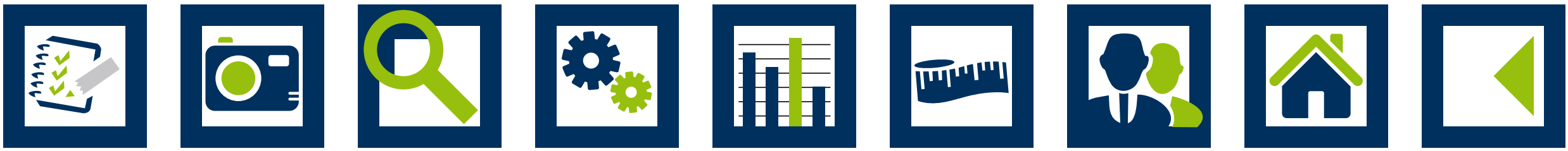

For “yes-men”

Would you like lower investments? And high-performance?
Then you simply should not deprive your customers of the UniLine.

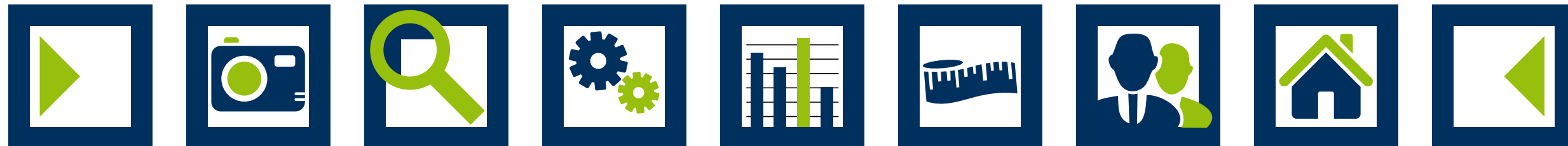

Step this way!

One step – and your customers are in a pleasant sales environment.
Open doors reduce our reluctance to enter a shop – and besides,
UniLine air screening reduces energy losses.

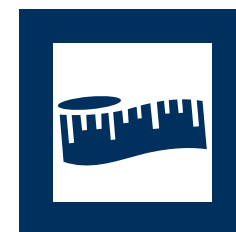
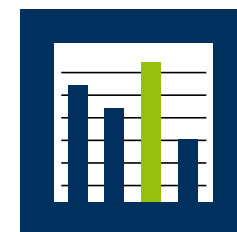

Small shops and large malls

You really can't avoid them: UniLine door air curtains effectively screen doors from cold air – with a height of up to four metres, individual or on a broad-scale.

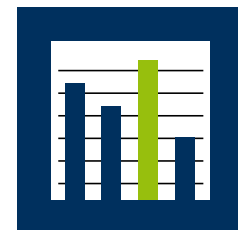

When it needs to be compact ...

... the simple connection is included: the unit and casing are a compact unit; the connections for electricity and water are lead out through the top.

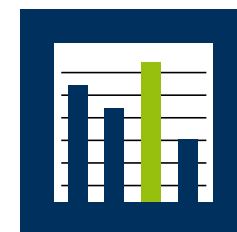

Maintenance-friendly and a pleasure to service

Make your service engineer your friend: the large filter along with the frame and air intake grille can be removed without any tools whatsoever. The large service flap is practical. The entire underside of the unit can be opened in just a few simple steps.

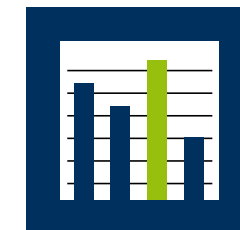

A reliable choice

UniLine is the door air curtain all-rounder. You can reliably choose the right unit for your project from our streamlined and comprehensive range.

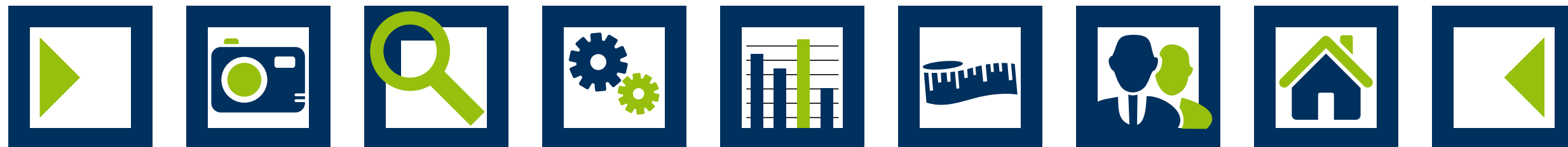

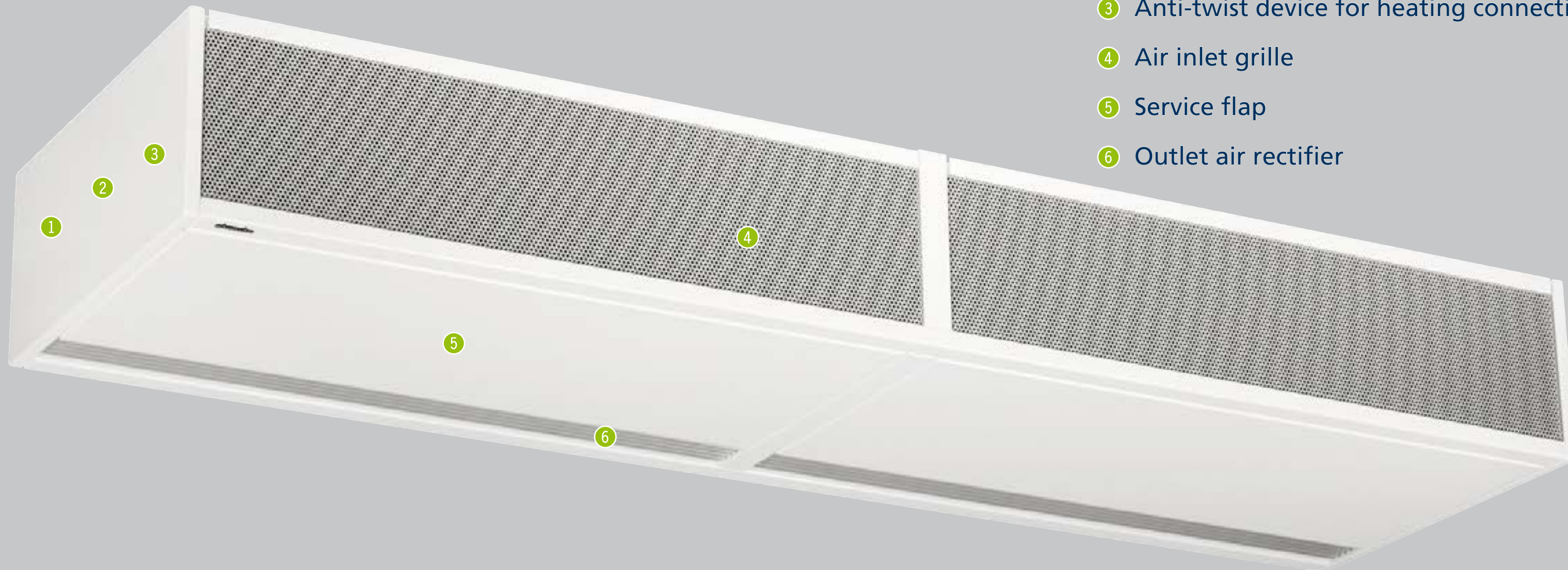

- ① Radial fan
- ② High-performance heat exchanger
- ③ Anti-twist device for heating connection
- ④ Air inlet grille
- ⑤ Service flap
- ⑥ Outlet air rectifier

UniLine at a glance

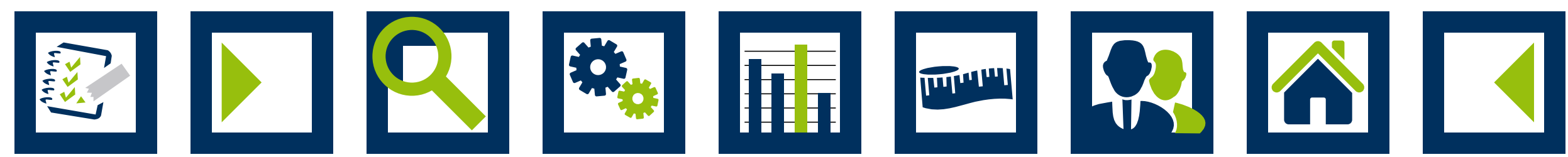



Radial fan

- ▶ High-performance radial fans for high air volumes

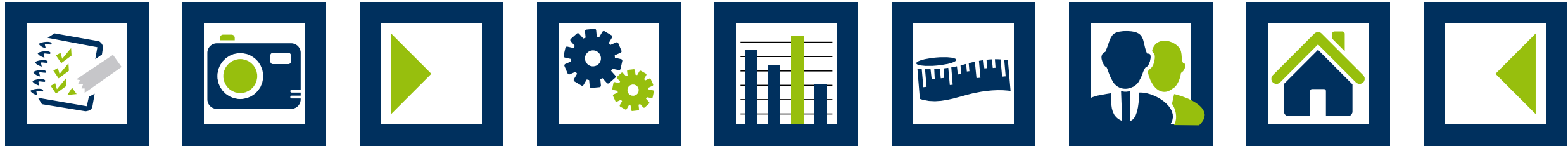

High-performance heat exchanger

- ▶ A proven combination of copper/aluminium
- ▶ Optimised for airflow and heat dissipation

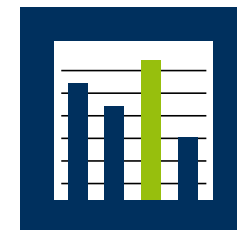



Anti-twist device for heating connection

- ▶ Prevents damage to the convector when screwing in the valves
- ▶ Optional: valves (accessories)

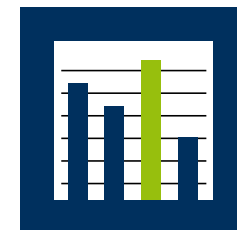

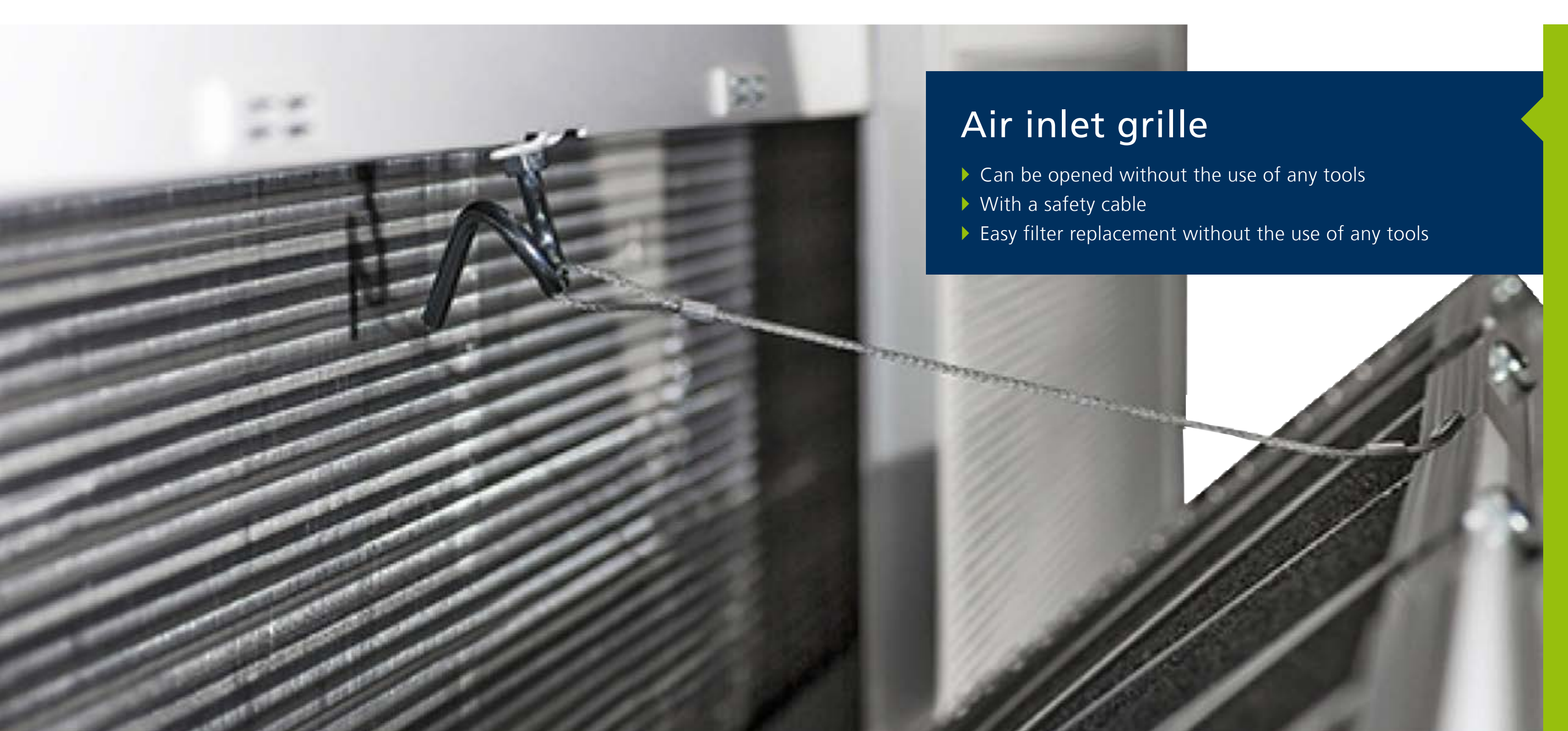

Air inlet grille

- ▶ Can be opened without the use of any tools
- ▶ With a safety cable
- ▶ Easy filter replacement without the use of any tools

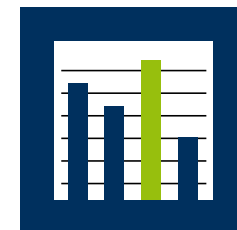

Controller models



KaControl room automation

- ▶ Factory-fitted KaControl technology to set up networked total systems based on a KaControl system
- ▶ Interfaces for BACnet* or Modbus building automation as an optional plug-in unit
- ▶ 0-10 V analog input to control the fan and valve via a single data point
- ▶ Room control unit design with intuitive user guidance
- ▶ Integrated timer programme

* Web server integrated

5-speed flush-mounted switch

- ▶ For installation in a 55 mm junction switch box
- ▶ Cover: white



5-speed surface-mounted switch

- ▶ In combination with a thermoelectric shut-off valve (accessories)
- ▶ In a plastic housing
- ▶ Light grey/dark grey

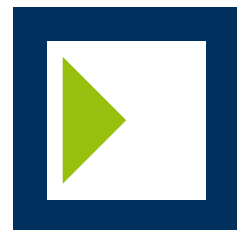

Technical Data UniLine

Size		10	15	20	25	30
Maximum discharge height ¹⁾	[m]	2,0 - 3,0	2,3 - 3,0	2,3 - 3,0	2,3 - 3,0	2,3 - 3,0
Maximum door width	[m]	1,0	1,5	2,0	2,5	3,0
Air flow volume ²⁾	[m ³ /h]	600 - 1390	930 - 2130	1210 - 2820	1660 - 4000	2210 - 5330
Heat output ³⁾	[kW]	6,7 - 10,2	9,6 - 17,4	13,1 - 24,2	18,0 - 33,9	24,1 - 44,2
Sound pressure level ⁴⁾	[dB(A)]	36 - 57	37 - 58	39 - 59	40 - 60	42 - 62

¹⁾ At good to average pressure ratios/requirements/conditions ²⁾ Switchable in 5 stages ³⁾ At LPHW 75/65 °C, t_{L1} = 20 °C ⁴⁾ At a distance of 3 m



Dimensions

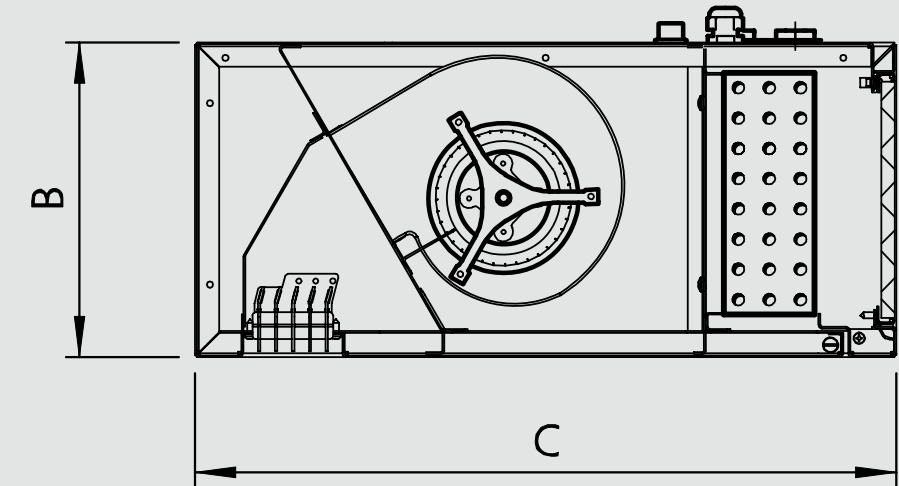
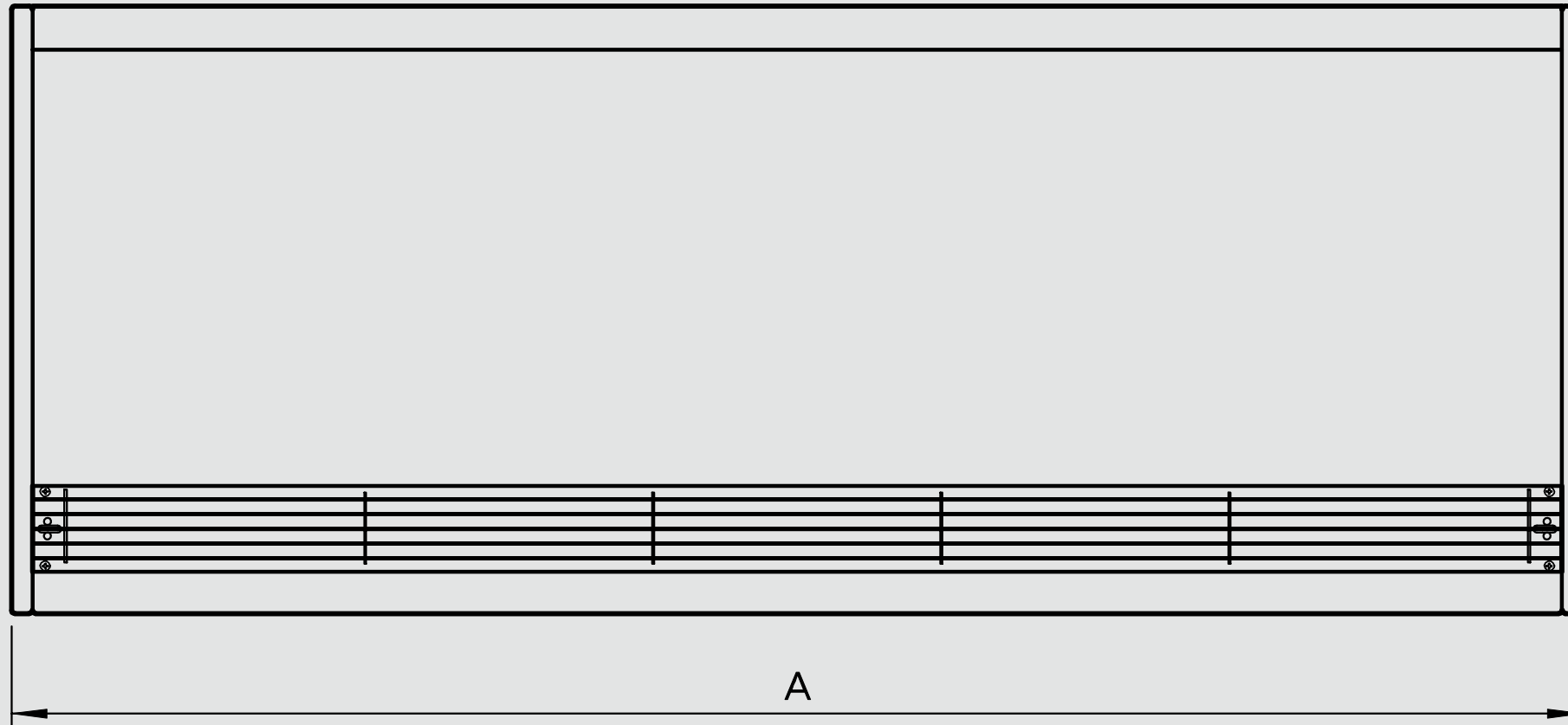

	UniLine				
Size	10	15	20	25	30
A	1000	1500	2000	2500	3000
B	260	260	260	260	260
C	580	580	580	580	580

All dimensions in mm

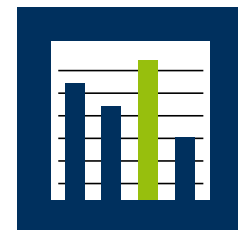

Benefits for you!

Kampmann offers you the following service benefits:

- ▶ On-site Consultation
- ▶ Design Support
- ▶ After Sales Service

Here we are at your service:
Kampmann.co.uk/contact

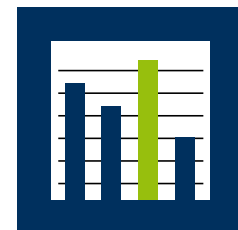

Kampmann.co.uk
m.kampmann.co.uk



Kampmann GmbH
Friedrich-Ebert-Str. 128–130
49811 Lingen (Ems)
Germany

T +49 591 7108-0

F +49 591 7108-300

E info@kampmann.de

Kampmann UK Ltd.
Dial House, Govett Avenue
Shepperton, Middlesex, TW17 8A
Great Britain

T +44 (0)1932 228592

F +44 (0)1932 228949

E info@kampmann.co.uk



KAMPMAN
Genau mein Klima.